

GIA NATURAL COLORED DIAMOND REPORT

September 29, 2025

Report Type ..... Grading Report

GIA Report Number ..... 6481980820

Shape and Cutting Style ..... Oval Brilliant

Measurements ..... 9.26 x 6.48 x 4.19 mm

Carat Weight ..... 1.70 carat

Color Grade ..... Fancy Deep Yellowish Green\*

Color Origin ..... Treated

Color Distribution ..... Even

Clarity Grade ..... VS1

Proportions:

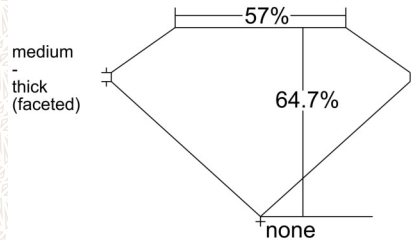

Profile not to actual proportions

Polish ..... Very Good

Symmetry ..... Very Good

Fluorescence ..... None

Inscription(s): GIA 6481980820, TREATED COLOR

Comments: Additional clouds are not shown. Pinpoints are not shown.

\* This diamond has been treated by one or more processes to change its color.

ADDITIONAL INFORMATION

GIA COLORED DIAMOND SCALE

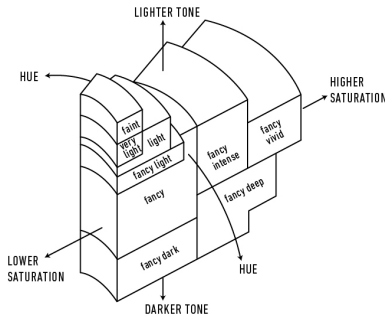
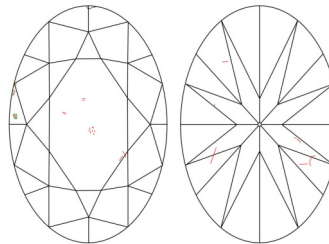

Illustration of GIA fancy color grade interrelationships





GIA CLARITY SCALE

FLAWLESS
INTERNALLY FLAWLESS
VVS <sub>1</sub>
VVS <sub>2</sub>
VS <sub>1</sub>
VS <sub>2</sub>
SI <sub>1</sub>
SI <sub>2</sub>
I <sub>1</sub>
I <sub>2</sub>
I <sub>3</sub>

CLARITY CHARACTERISTICS



KEY TO SYMBOLS\*

-  Cloud
-  Extra Facet
-  Cavity
-  Feather
-  Indented Natural

\* Red symbols denote internal characteristics (inclusions). Green or black symbols denote external characteristics (blemishes). Diagram is an approximate representation of the diamond, and symbols shown indicate type, position, and approximate size of clarity characteristics. All clarity characteristics may not be shown. Details of finish are not shown.



reportcheck.gia.edu



The results documented in this report refer only to the diamond described, and were obtained using the techniques and equipment available to GIA at the time of examination. This report is not a guarantee or valuation. For additional information and important limitations and disclaimers, please see GIA.edu/terms or call +1 800 421 7250 or +1 760 603 4500. ©2023 Gemological Institute of America, Inc.

 THE SECURITY FEATURES IN THIS DOCUMENT, INCLUDING THE HOLOGRAM, SECURITY SCREEN AND MICROPRINT LINES, IN ADDITION TO THOSE NOT LISTED, EXCEED DOCUMENT SECURITY INDUSTRY GUIDELINES.